

Pump Pompe Pumpen Pompa	Pressure Pression Druck Pressione		Volume Débit Leistung Portata		RPM tours/min u.p.m. giri/min	Required HP Puissance HP Leistung HP Potenza HP	Inlet port Entrée Eingang Aspirazione	Outlet Sortie Ausgang Mandata	Weight Kg Poids Kg Gewicht Kg Peso Kg
	bar	PSI	l/min	GPM					
NMT1220S	200	3000	12.5		1000	6.4	G 1/2	G 3/8	9.5
				4.0	1200	7.7			
NMT1520S	200	3000	15.0		1000	7.7	G 1/2	G 3/8	9.5
				4.7	1200	9.2			
NMT1220	200	3000	12.5		1450	6.4	G 1/2	G 3/8	9.5
				4.0	1740	7.7			
NMT1520	200	3000	15.0		1450	7.7	G 1/2	G 3/8	9.5
				4.7	1740	9.2			
NMT1820	200	3000	18.0		1450	9.2	G 1/2	G 3/8	9.5
				5.6	1740	11.0			
NMT2120	200	3000	21.0		1450	10.7	G 1/2	G 3/8	9.5
				6.6	1740	12.8			

Dimensioni d' ingombro

Overall dimensions

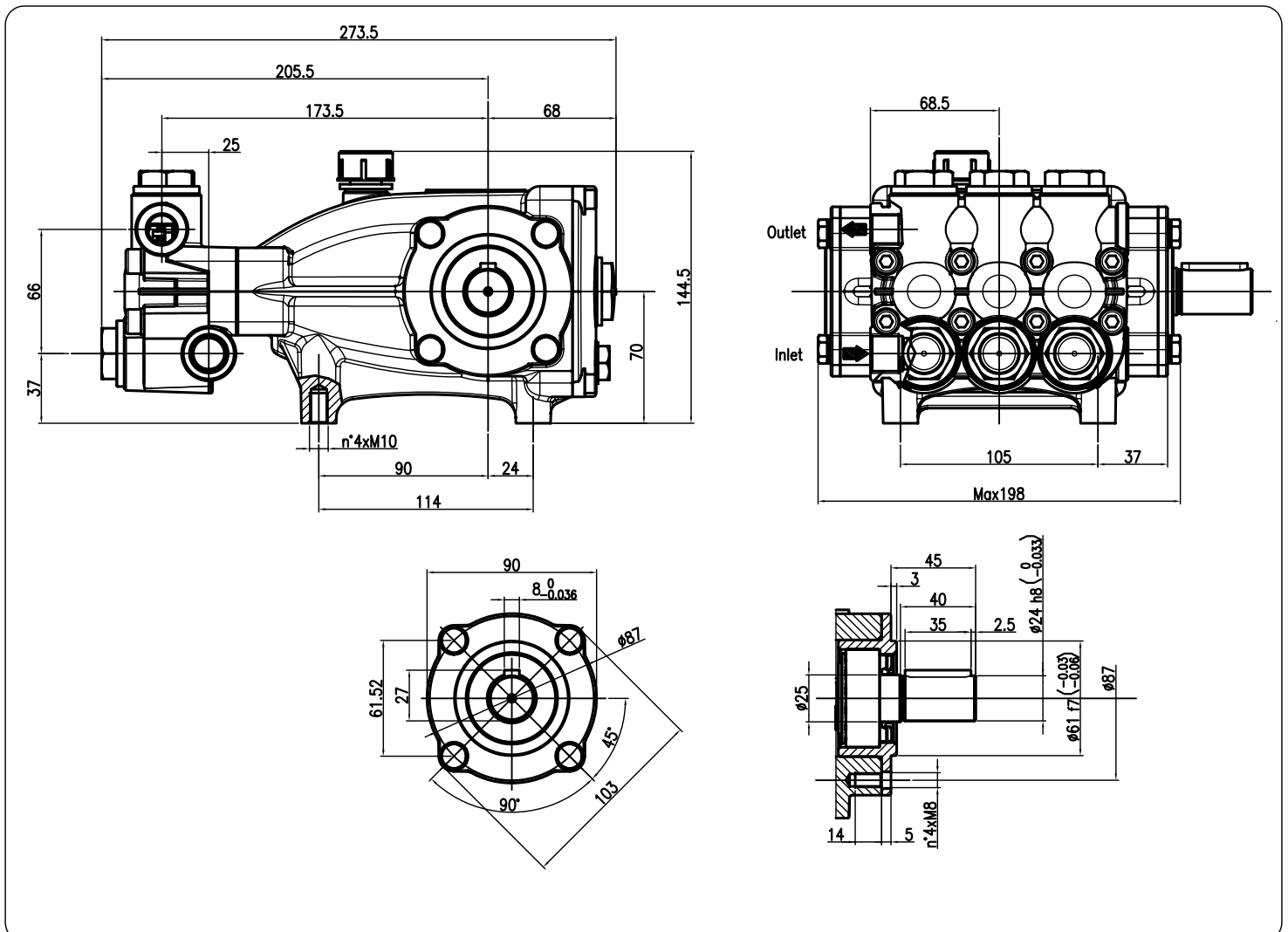

Lubrificazione: Olio SAE 20/40W
Capacità 0.7 litri

Lubrication: SAE 20/40W Oil
Capacity 0.7 liters

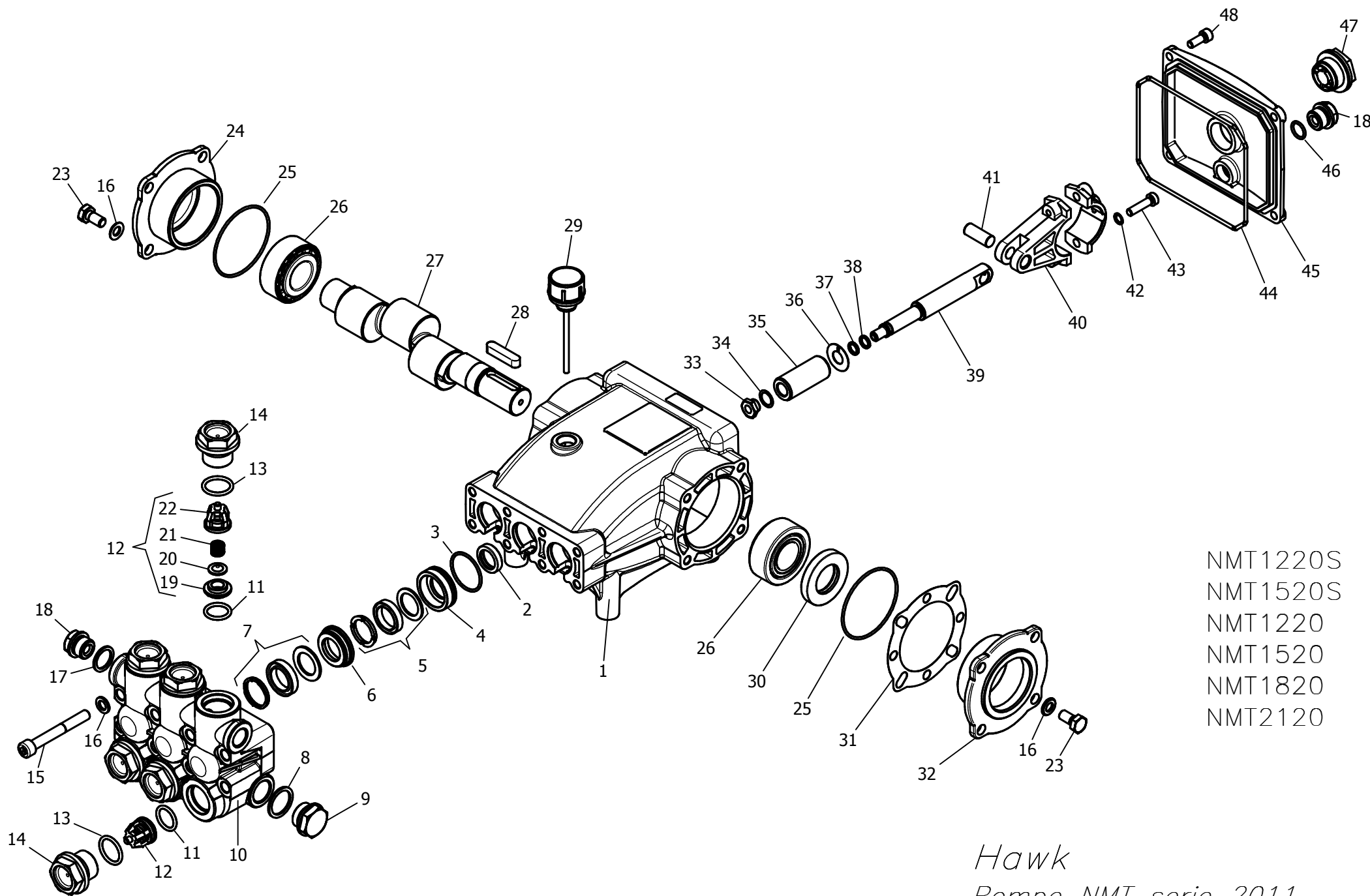

NMT1220S
 NMT1520S
 NMT1220
 NMT1520
 NMT1820
 NMT2120

Hawk
Pompe NMT serie 2011
NMT pumps 2011 series

NMT 2011

SPARE PARTS KIT

KIT RICAMBI

Posizioni Item	Part Number and Description	Codice e descrizione	Q.tà per ogni Pompa Q.ty for each Pump	NMT1220SRL	NMT1520SRL	NMT1220RL	NMT1520RL	NMT1820RL	NMT2120RL
3- 5- 7	2600.77 Plunger Seals 20 mm	2600.77 Guarnizioni pistone Ø20	1						
3- 4- 5- 6- 7	2600.78 Complete Seals Packing 20 mm	2600.78 Pacco completo Guarnizioni pistone Ø20	3						
33- 34- 35- 36 37- 38	2601.07 Plunger 20 mm	2601.07 Pistone Ø20	3						
11- 12- 13	2600.08 Complete Valve	2600.08 Valvola completa	6	◆	◆	◆	◆	◆	◆
2	2608.03 Plunger oil Seals	2608.03 Anelli tenuta olio Asta	1						
3- 4- 5- 6- 7- 8 9- 10- 11- 12 13- 14 17- 18	2600.69 Complete Manifold	2600.69 Testata Completa	1						
39- 40- 41- 42 43	3100.13 Connecting Rod-Plunger Rod Assy	3100.13 Premontato Biella-Asta pistone	3						

PARTS LIST

LISTA PARTI

Pos. Item	Codice Part Number	Description	Descrizione	Q.tà per ogni Pompa Q.ty for each Pump	NMT1220SRL	NMT1520SRL	NMT1220RL	NMT1520RL	NMT1820RL	NMT2120RL
1	0202.95	Crankcase	Carter	1						
*2	0001.03	Plunger oil seal	Anello radiale	3						
*3	0601.07	"O" Ring Ø1.78x31.47	"O" Ring Ø1.78x31.47	3						
*4	1201.37	Pressure ring 20mm	Pressore "U" Ø20	3						
*5	0002.52	Low pressure "U" seal, dia.20mm	Anello tenuta "U" Ø20	3						
*6	0300.60	Intermed. ring 20mm	Diffusore Intermed. Ø20	3						
*7	0002.60	High pressure "U" seal, dia.20mm	Anello tenuta "U" Ø20	3						
*8	0603.07	Copper washer G1/2	Guarnizione rame	1						
*9	1601.20	Brass plug G1/2	Tappo G1/2	1						
*10	1602.34	Manifold housing	Testata	1						
*11	0601.19	"O" Ring Ø2.62x17.13	"O" Ring Ø2.62x17.13	6						
*12	3604.70	Valve assembly	Valvola premontata	6						
*13	0601.65	"O" Ring Ø2.62x20.29	"O" Ring Ø2.62x20.29	6						
*14	1601.30	Valve plug	Tappo valvola	6	◆	◆	◆	◆	◆	◆
15	1801.03	Manifold stud bolt M8x65 Dacromet	Vite M8x65 Dacromet	8						
16	1400.01	Washer Ø8,5	Rosetta Ø8.5	16						
*17	0603.06	Copper washer G3/8	Guarnizione rame	1						
*18	1601.17	Brass plug G3/8	Tappo G3/8	2						
19	1503.18	Valve seat	Sede valvola	6						
20	1202.00	Valve plate	Piattello valvola	6						
21	0900.30	Valve spring	Molla valvola	6						
22	0604.05	Valve cage	Gabbia valvola	6						
23	1802.03	Hexagonal screw M8x18	Vite M8x18	8						
24	0500.61	Closed bearing housing	Flangia chiusa	1						
25	0601.63	"O" Ring Ø1.78x60.05	"O" Ring Ø1.78x60.05	2						
26	0200.06	Roller bearing 33205	Cuscinetto a rulli 33205	2						

NMT 2011

PARTS LIST

LISTA PARTI

Pos. Item	Codice Part Number	Description	Descrizione	Q.tà per ogni Pompa Q.ty for each Pump	NMT1220SRL	NMT1520SRL	NMT1220RL	NMT1520RL	NMT1820RL	NMT2120RL
27	0006.17	Single - ended shaft	<i>Albero semplice P.d.F.</i>	1	◆				◆	
	0006.19	" " "	" " "	1		◆				
	0006.14	" " "	" " "	1			◆			
	0006.16	" " "	" " "	1				◆		
	0006.18	" " "	" " "	1						◆
28	0206.04	Crankshaft key	<i>Chiavetta</i>	1						
29	1600.06	Oil dip stick	<i>Tappo livello olio</i>	1						
30	0001.02	Crankshaft seal	<i>Anello radiale</i>	1						
31	0301.02	Shim	<i>Distanziale</i>	1						
32	0500.60	Bearing housing	<i>Flangia</i>	1						
*33	0302.19	Plunger nut	<i>Dado pistone</i>	3						
*34	1400.12	Copper spacer Ø 11.2/15x0.5	<i>Rosetta rame Ø 11.2/15x0.5</i>	3						
*35	1200.10	Plunger 20mm	<i>Pistone Ø20</i>	3						
*36	1400.15	Copper spacer Ø 11.3/24x0.5	<i>Rosetta rame Ø 11.3/24x0.5</i>	3						
*37	0601.03	"O" Ring Ø1.78x7.66	<i>"O" Ring Ø1.78x7.66</i>	3						
*38	0009.04	Teflon ring	<i>Anello antiestrusione</i>	3	◆	◆	◆	◆	◆	◆
*39	0003.28	Plunger rod	<i>Asta pistone</i>	3						
*40	0100.01	Connecting rod	<i>Biella</i>	3						
*41	1502.06	Connecting rod pin	<i>Spinotto</i>	3						
*42	1401.02	Spring washer Ø6	<i>Rosetta elastica Ø6</i>	6						
*43	1801.05	Connecting rod screw M6x25	<i>Vite M6x25</i>	6						
44	0601.88	"O" Ring Ø 2.62x126.67	<i>"O" Ring Ø 2.62x126.67</i>	1						
45	0203.59	Crankcase cover	<i>Coperchio posteriore</i>	1						
46	0601.14	"O" Ring Ø1.78x14	<i>"O" Ring Ø1.78x14</i>	1						
47	0700.05	Sight glass, G3/4	<i>Spia livello olio G3/4</i>	1						
48	1801.12	Screw M6x16	<i>Vite M6x16</i>	4						

**Part available
in kit only**

*** Part available
in kit also**